

CORA BIKE RACK

PRODUCT SPECIFICATION SHEET

SG-1 BIKE RACK

- A premium bike rack with an integrated **Scratch Guard™** bumper to protect bikes from damage
- Supports the entire bike frame and accommodates 2 bikes, 1 on each side
- Provides a superior user experience and flexible layout design

SCRATCH GUARD™ BUMPER TO **PROTECT** BIKES FROM DAMAGE



SG-1
(Scratch Guard™ Bike Rack)

DESIGNED FOR
BIKES WITH



ANY WHEEL
DIAMETER



ANY TYRE
WIDTH



ANY WEIGHT

FENDERS /
MUDGUARDS
= YES

SPECIFICATIONS

Capacity	Finish	Fixings	Assembly	Construction	Compliance
2 bikes per rack	- Cora ceramic or colour powder coat range - 304 stainless steel	4 x M12 x 80mm anchor bolts with tamper resistant fasteners	Supplied fully welded and assembled	Dual skin metal with durable polymer bumper insert	AS2890.3 (2015) compliant

CORA BIKE RACK

PRODUCT SPECIFICATION SHEET

SG-1 BIKE RACK

LAYOUT GUIDE

BIKE RACK SPACING - 1000mm minimum between bikes and 500mm minimum to a wall or other obstruction

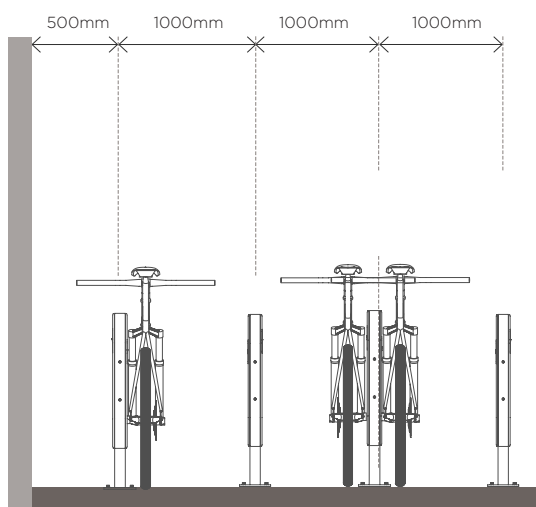

FRONT VIEW

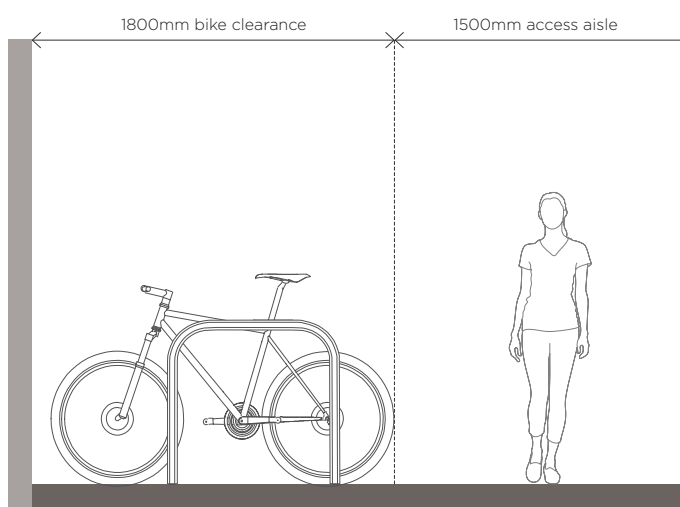

SIDE VIEW

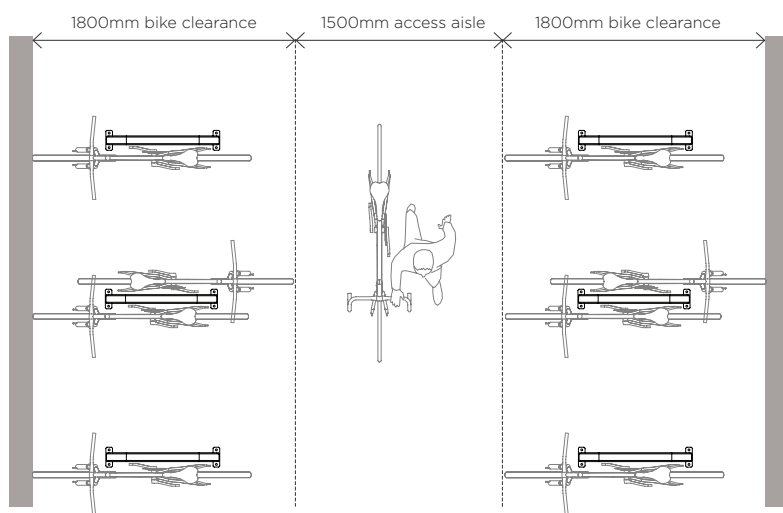

TOP VIEW

Refer to Installation Instructions sheet for specific installation and assembly guidelines. Racks should **NOT** be installed based on this sheet alone.

sales@cora.com.au
www.cora.com.au